

7075 Place Robert-Joncas, Saint-Laurent, QC, H4M 2Z2

Suite #97-99

Among the many perks of the property are a prime location near numerous amenities, easy access by car and public transit, and highly competitive rental rates. But most of all, it gives you flexibility.

Create a work environment that is pleasant and productive, all at an affordable price. You can configure your offices and storage facilities to suit your needs. Our years of architects and designers will do everything to exceed your expectations.

This will allow you to create a productive and pleasant working environment at very reasonable costs. Located near major arteries, 10 minutes from Montreal-Trudeau International Airport and within walking distance of several bus and service lines, Place Robert-Joncas is a prime location for both your employees and your customers.



Building characteristics

TOTAL LEASING AREA	218,611 sq. ft.
LAND AREA	439,498 sq. ft.
YEAR OF RENOVATION	2003
YEAR OF CONSTRUCTION	1975
NUMBER OF FLOORS	2
ASCENCEURS	1
SPRINKLERS	Yes
SECURITY	Access cards

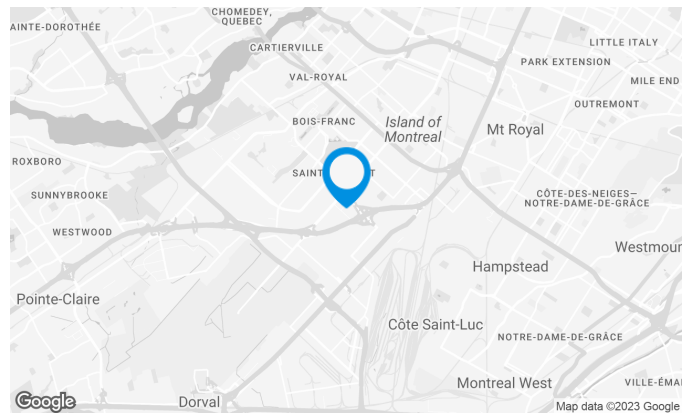

BUILDING ACCESSIBILITY

OUTDOOR PARKING	396
ROAD ACCESS	Côte-Vertu Blvd, Cavendish Blvd, Highways 13, 15, 40 and 520
BUS	470, 177, 196, 216,409
METRO STATION	Côte-Vertu

Space characteristics

AVAILABLE LEASING AREA 2,052 sq. ft.

AVAILABILITY Immediate

FLOOR AREA 178,826 sq. ft.

ADDITIONAL RENT \$7.86 /sq. ft.

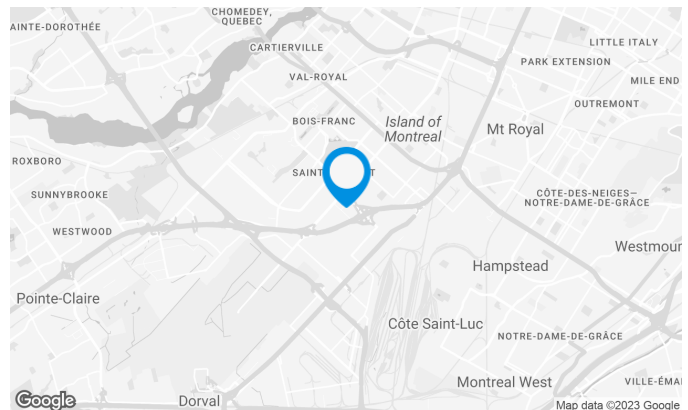
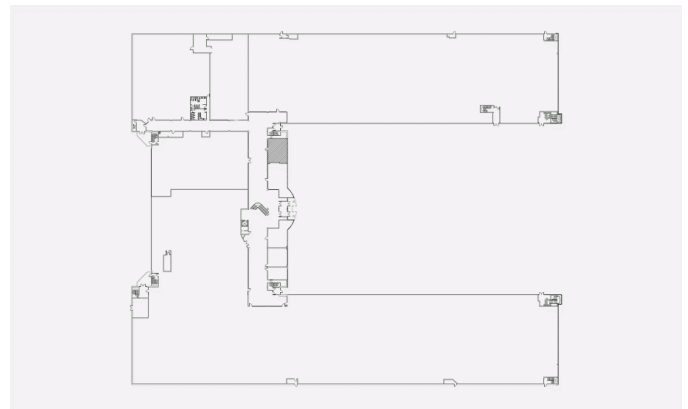
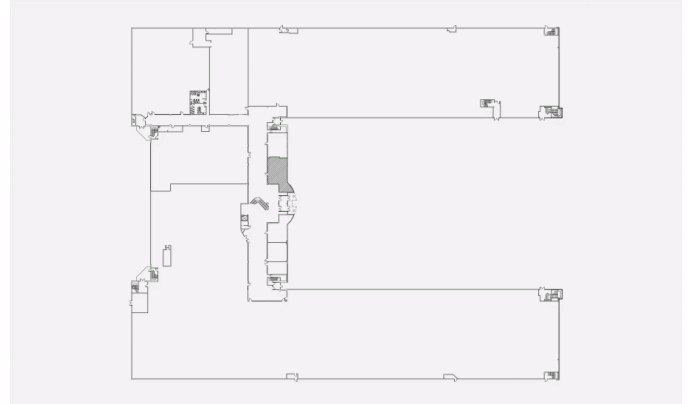

LOCATION PLAN - LOCAL 97

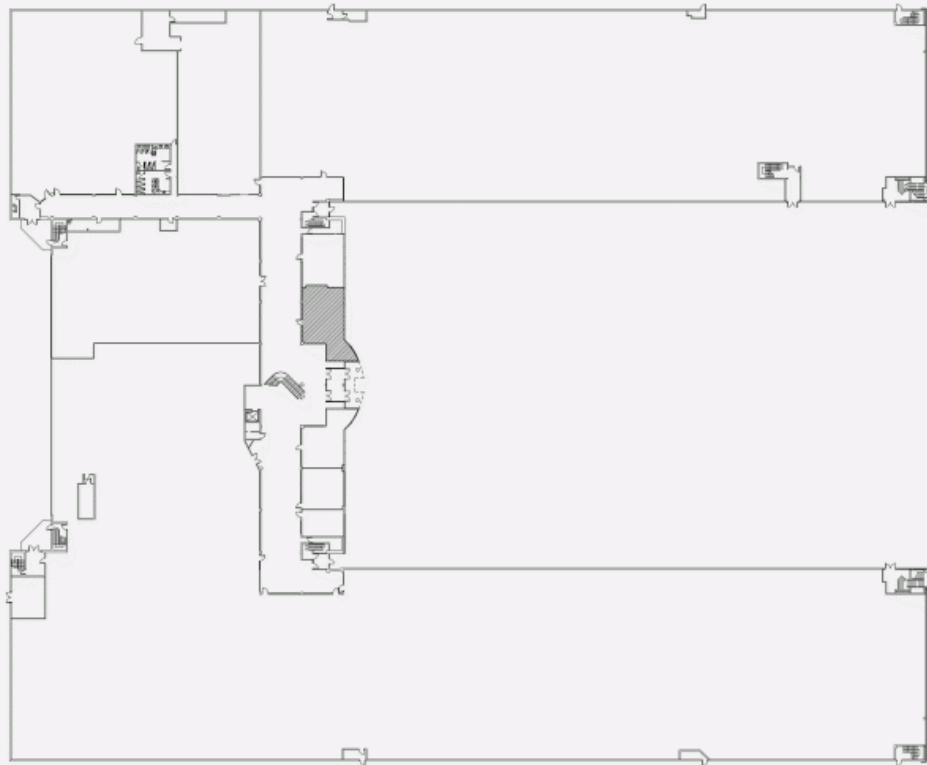

LOCATION PLAN - LOCAL 99

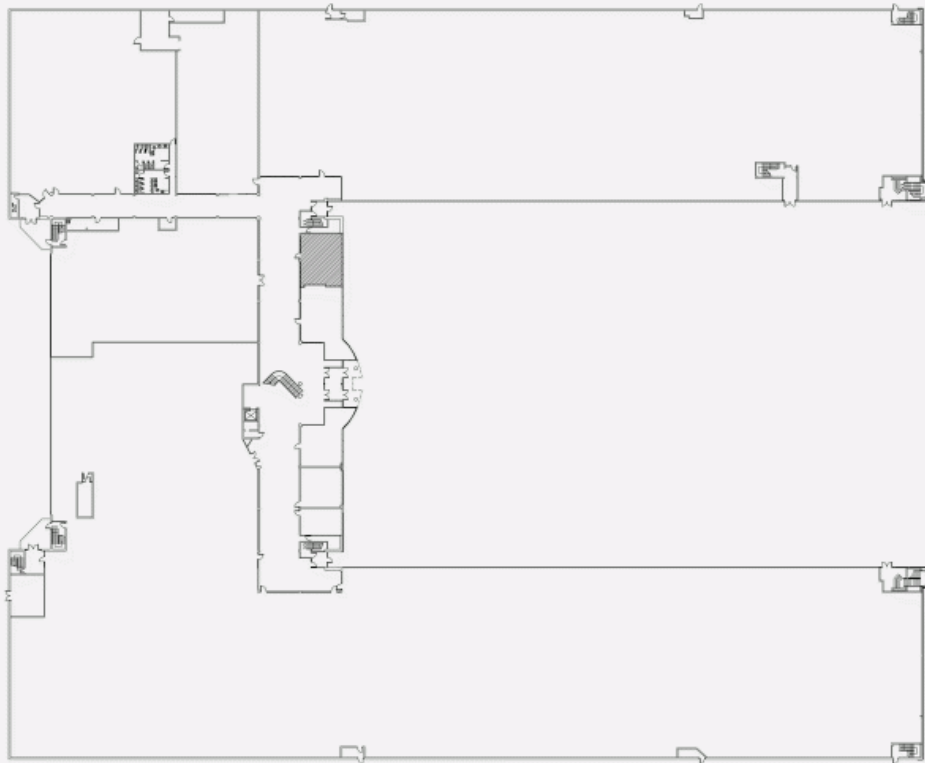

LAYOUT PLAN - LOCAL 97

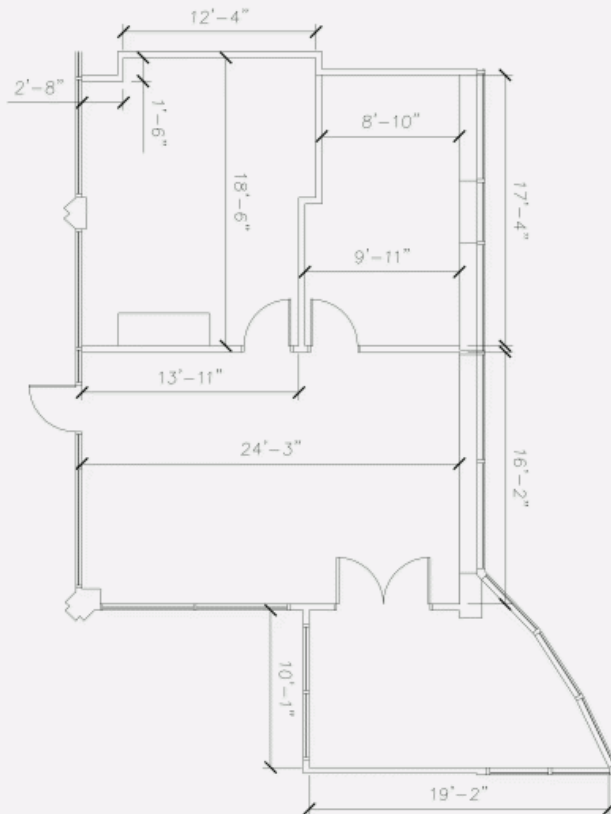

LAYOUT PLAN - LOCAL 99

